

# Initial R Words

Instructions \_\_\_\_\_

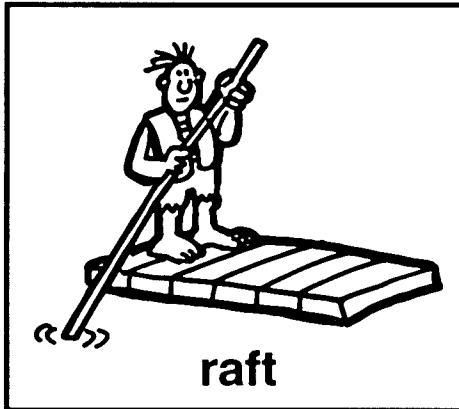

--	--	--	--	--	--	--	--	--	--

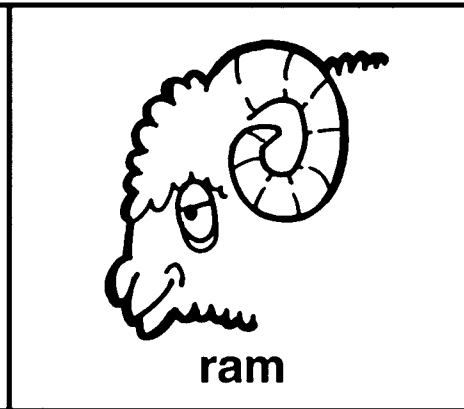

--	--	--	--	--	--	--	--	--	--



--	--	--	--	--	--	--	--	--	--

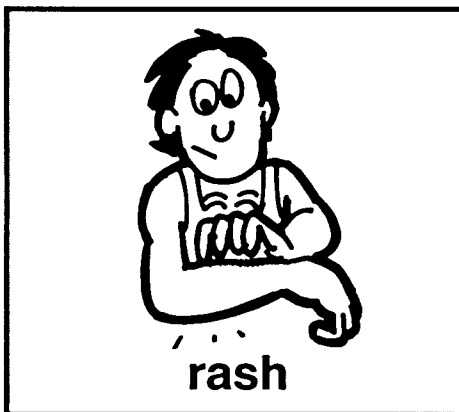

--	--	--	--	--	--	--	--	--	--

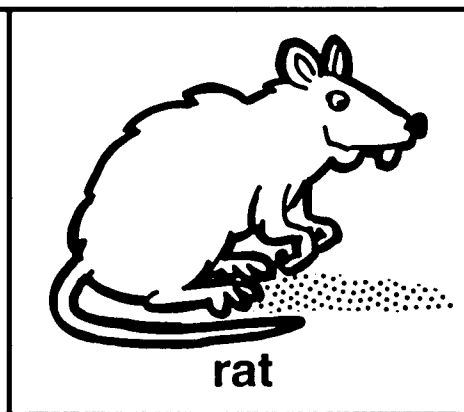

--	--	--	--	--	--	--	--	--	--

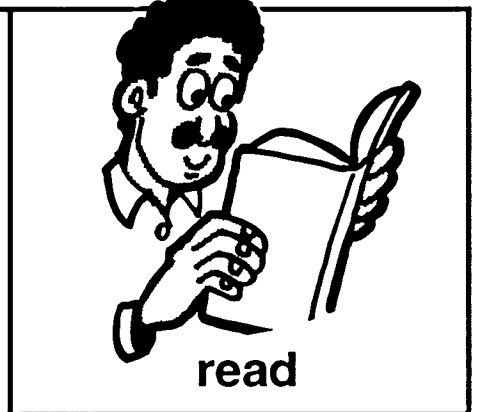

--	--	--	--	--	--	--	--	--	--

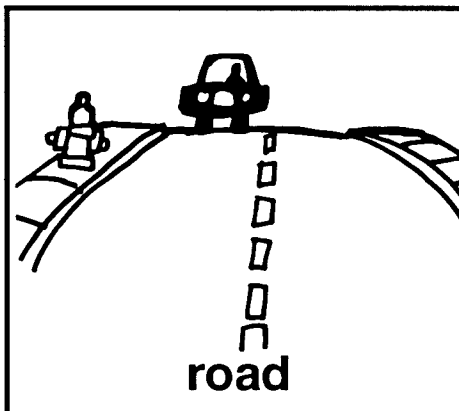

--	--	--	--	--	--	--	--	--	--

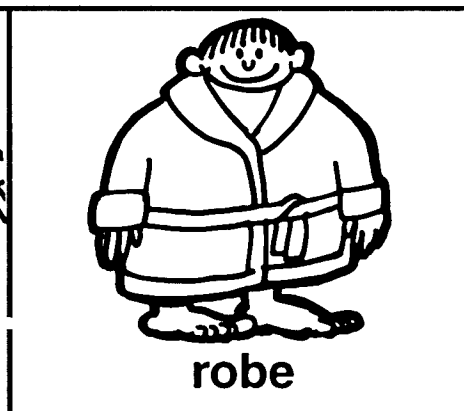

--	--	--	--	--	--	--	--	--	--

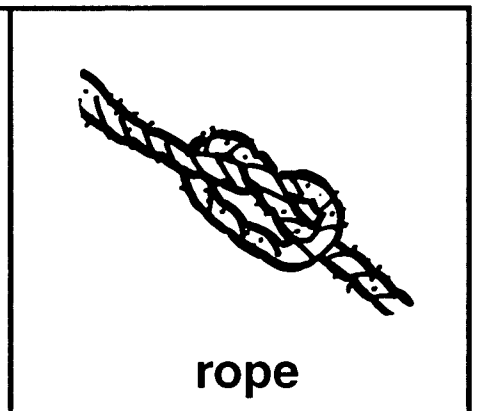

--	--	--	--	--	--	--	--	--	--

Name \_\_\_\_\_

Date \_\_\_\_\_

Helper's Signature \_\_\_\_\_

Skill: Initial R in words

Speech-Language Pathologist \_\_\_\_\_

# Initial R Words

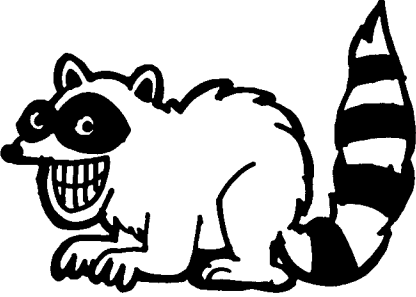
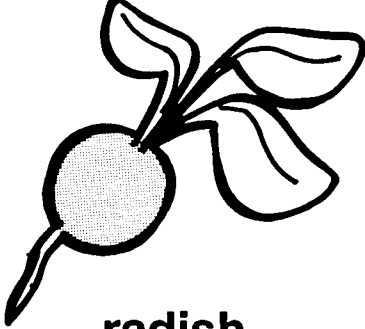
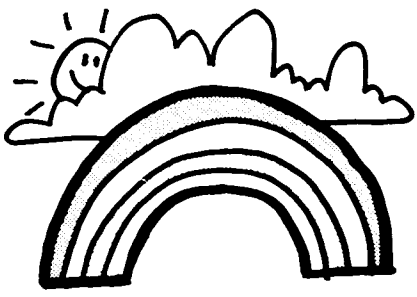

Instructions \_\_\_\_\_

 <p><b>raccoon</b></p>	 <p><b>radish</b></p>	 <p><b>rainbow</b></p>
---	---	---

--	--	--	--	--	--	--	--	--	--	--	--

--	--	--	--	--	--	--	--	--	--	--	--

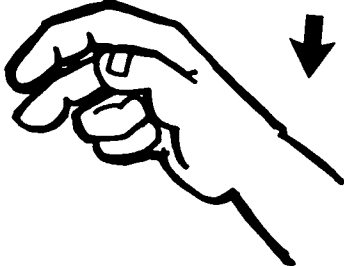
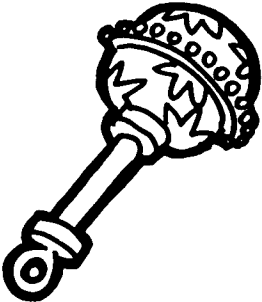

--	--	--	--	--	--	--	--	--	--	--	--

 <p><b>wrist</b></p>	 <p><b>rattle</b></p>	 <p><b>raincoat</b></p>
--	---	---

--	--	--	--	--	--	--	--	--	--	--	--

--	--	--	--	--	--	--	--	--	--	--	--

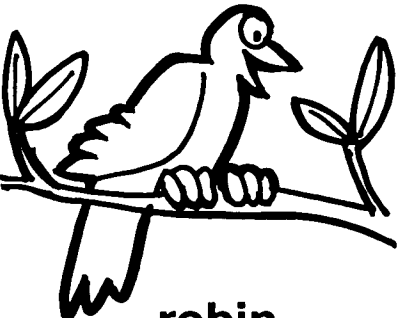
--	--	--	--	--	--	--	--	--	--	--	--

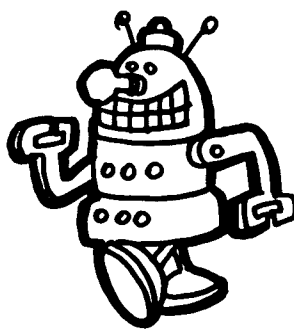
 <p><b>robin</b></p>	 <p><b>ribbon</b></p>	 <p><b>robot</b></p>
---	--	---

--	--	--	--	--	--	--	--	--	--	--	--

--	--	--	--	--	--	--	--	--	--	--	--

--	--	--	--	--	--	--	--	--	--	--	--

Name \_\_\_\_\_

Date \_\_\_\_\_

Helper's Signature \_\_\_\_\_

Skill: Initial R in words

Speech-Language Pathologist \_\_\_\_\_

# Initial R Phrases



Instructions \_\_\_\_\_  
\_\_\_\_\_  
\_\_\_\_\_

1. in the race
2. a rainy day
3. raking leaves
4. ran fast
5. a red rash
6. read a book
7. pay the rent
8. rinsing dishes
9. a rotten roof
10. give to Ruth
11. right or wrong
12. win the raffle
13. Ray and Ron
14. any reason
15. get ready now
16. shake a rattle
17. time to relax
18. the pink ribbon
19. baby robins
20. in the rocket

21. rocky road
22. rosy cheeks
23. a cold remedy
24. my refund
25. row the boat
26. in a rush
27. cooking roast
28. rich enough
29. a loud radio
30. resting easy
31. rip in pants
32. jumping rope
33. new rules
34. my white robe
35. out of reach
36. box of raisins
37. pack of rats
38. ramble along
39. eat a radish
40. a good reason

© 1993, Super Dupare School Co.

Name \_\_\_\_\_

Date \_\_\_\_\_

Helper's Signature \_\_\_\_\_

Skill: Initial R in phrases

Speech-Language Pathologist



# Initial R Sentences

## Instructions

© 1993, Super Dupers School Co.

1. I will run a race.
2. Is it raining?
3. Rats like to eat cheese.
4. Sit and rest awhile.
5. Ron reads books.
6. Can you reach the cookies?
7. This road is bumpy.
8. Are you ready to go?
9. The red roses are lovely.
10. Did Rick see the robin?
11. Ruth will rake the leaves.
12. The rusty rocket is old.
13. Please eat the raisins.
14. Rachel's room is messy.
15. My raccoon ran away.
16. Is it time for recess?
17. The rent is due now.
18. Roxy has a ruby ring.
19. Do you like roast beef?
20. Is that rash poison ivy?

21. Ray wrapped the gift.
22. The roof is leaky.
23. My blouse has ruffles.
24. Please pass the relish.
25. Rabbits are good pets.
26. His pants have a rip.
27. I really like radishes.
28. Is this the right one?
29. Ripe bananas taste good.
30. Mom got a pay raise.
31. Randy runs fast.
32. The radio is really loud!
33. What a beautiful rainbow!
34. A snake is a reptile.
35. Please follow the rules.
36. Can you row the boat?
37. It's time to relax.
38. Roaches are yucky.
39. Do you play rugby?
40. You can rely on me!

Name \_\_\_\_\_

Date \_\_\_\_\_

Helper's Signature \_\_\_\_\_

Skill: Initial R in sentences

Speech-Language Pathologist

# Medial R Words

Instructions \_\_\_\_\_

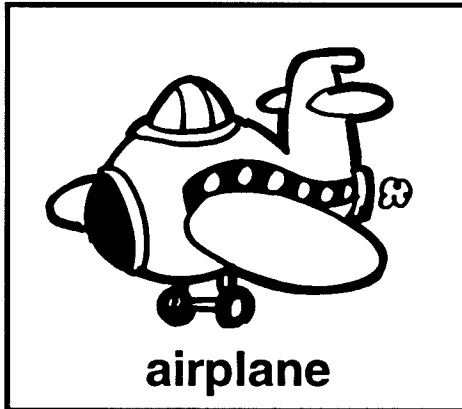

--	--	--	--	--	--	--	--	--	--	--	--

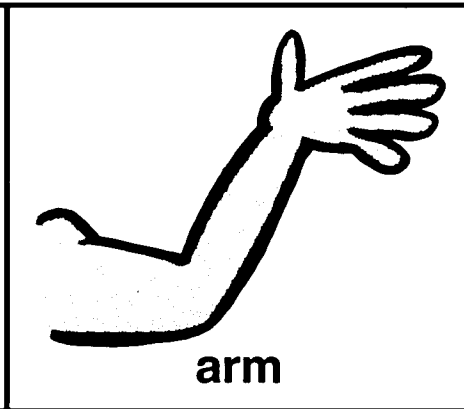

--	--	--	--	--	--	--	--	--	--	--	--

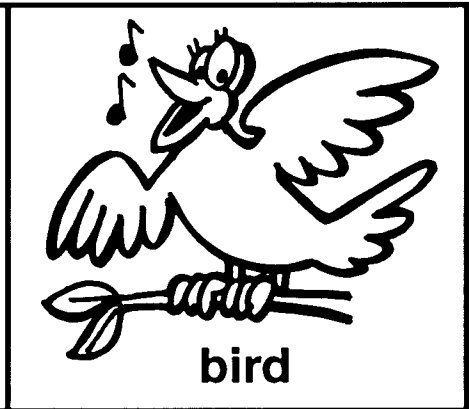

--	--	--	--	--	--	--	--	--	--	--	--

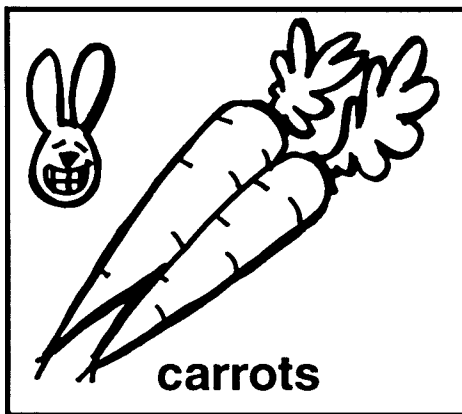

--	--	--	--	--	--	--	--	--	--	--	--

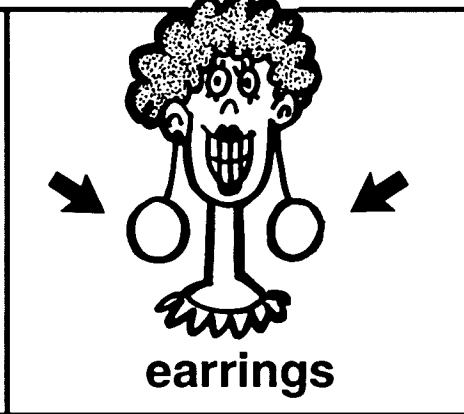

--	--	--	--	--	--	--	--	--	--	--	--

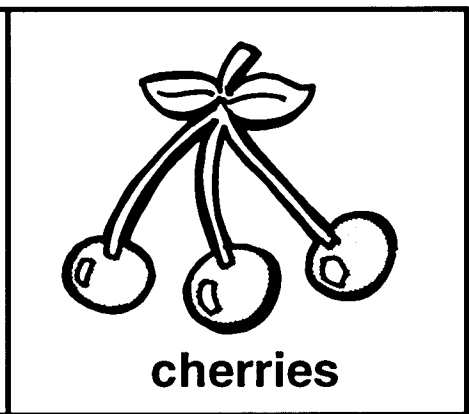

--	--	--	--	--	--	--	--	--	--	--	--



--	--	--	--	--	--	--	--	--	--	--	--

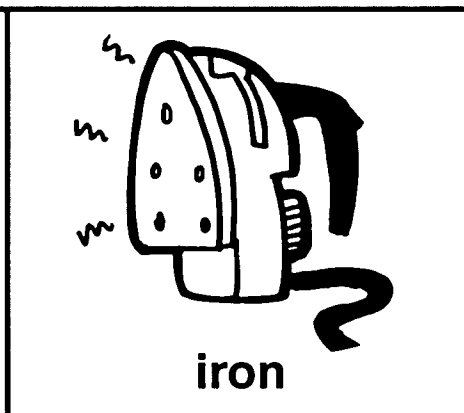

--	--	--	--	--	--	--	--	--	--	--	--

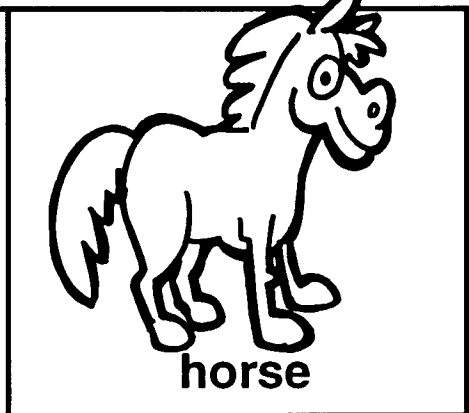

--	--	--	--	--	--	--	--	--	--	--	--

Name \_\_\_\_\_

Date \_\_\_\_\_

Helper's Signature \_\_\_\_\_

Skill: Medial R in words

Speech-Language Pathologist

# Medial R Words

Instructions \_\_\_\_\_

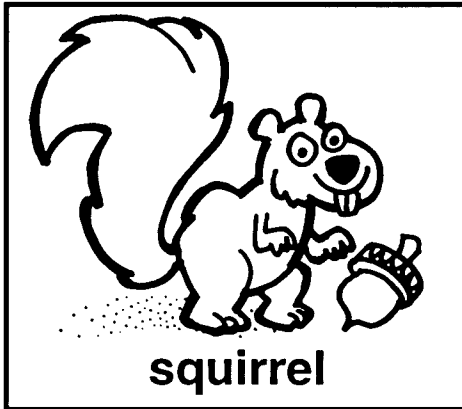

--	--	--	--	--	--	--	--	--	--	--	--

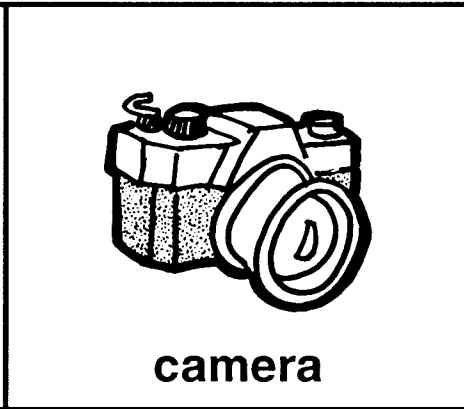

--	--	--	--	--	--	--	--	--	--	--	--

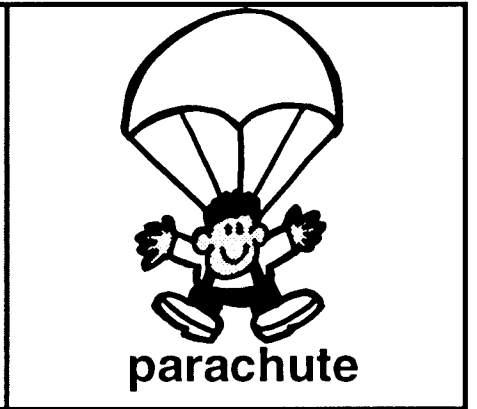

--	--	--	--	--	--	--	--	--	--	--	--



--	--	--	--	--	--	--	--	--	--	--	--

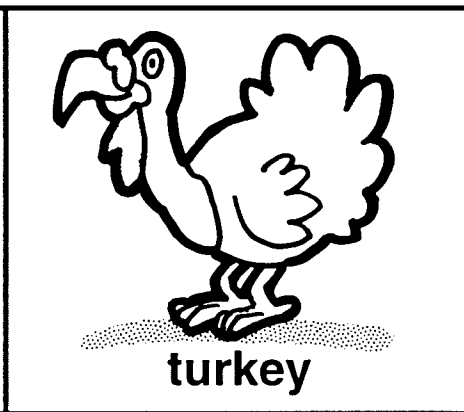

--	--	--	--	--	--	--	--	--	--	--	--

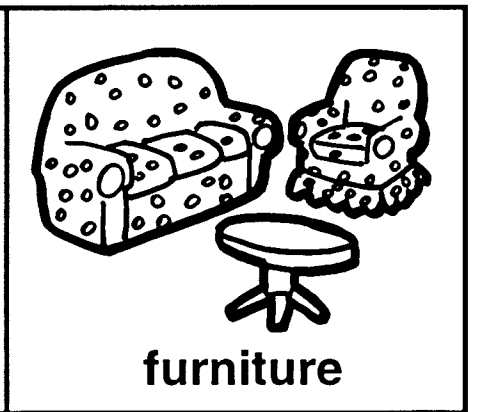

--	--	--	--	--	--	--	--	--	--	--	--

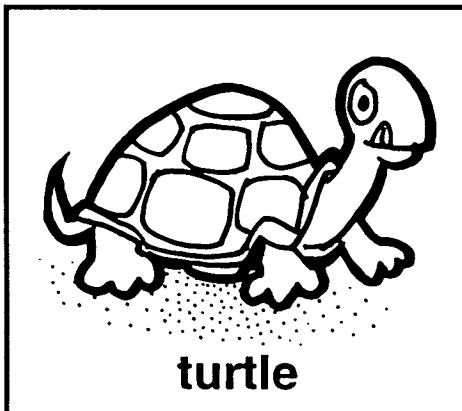

--	--	--	--	--	--	--	--	--	--	--	--

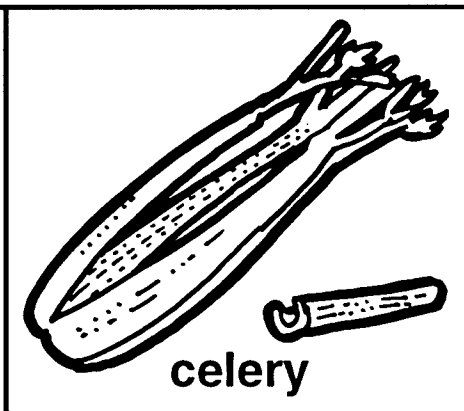

--	--	--	--	--	--	--	--	--	--	--	--

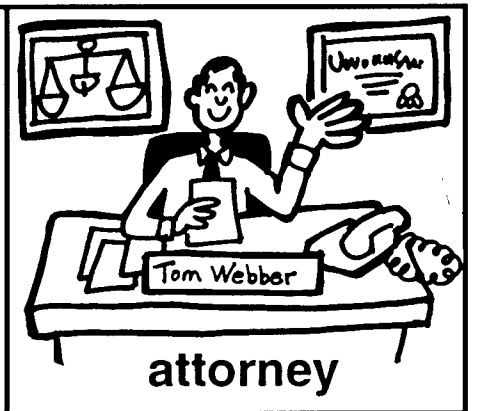

--	--	--	--	--	--	--	--	--	--	--	--

Name \_\_\_\_\_

Date \_\_\_\_\_

Helper's Signature \_\_\_\_\_

Skill: Medial R in words

Speech-Language Pathologist

# Medial R Phrases

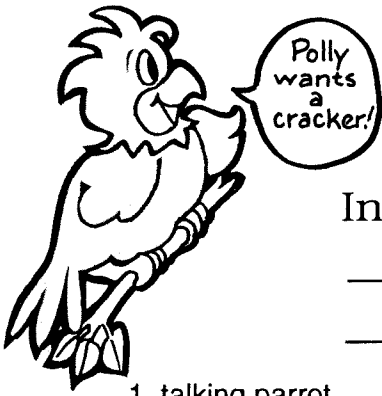

Instructions \_\_\_\_\_

\_\_\_\_\_

\_\_\_\_\_

1. talking parot
2. clean carpet
3. spoon and fork
4. to the circus
5. Jerry and Larry
6. ironing clothes
7. send a card
8. barrel of monkeys
9. bowl of berries
10. playing marbbles
11. married to Karen
12. herd of cows
13. a little girl
14. make a circle
15. going to church
16. arms and legs
17. Gary's burro
18. love a parade
19. wearing pearls
20. apple and orange

21. hurry to work
22. very sorry
23. in my purse
24. Terry's parents
25. caring and sharing
26. Perry the pirate
27. shirt and skirt
28. in the park
29. eat a carrot
30. a nervous cat
31. the kind nurse
32. open parachute
33. his pet turtle
34. tell a story
35. starry night
36. in the garage
37. eat macaroni
38. happy gorilla
39. a long beard
40. forty lizards

© 1993, Super Dupere School Co.

Name \_\_\_\_\_

Date \_\_\_\_\_

Helper's Signature \_\_\_\_\_

Skill: Medial R in phrases

Speech-Language Pathologist \_\_\_\_\_

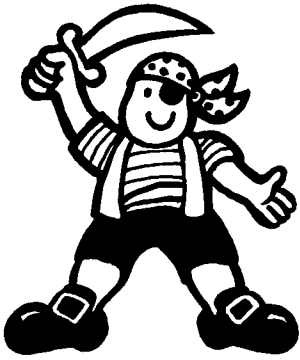

# Medial R Sentences

Instructions \_\_\_\_\_

\_\_\_\_\_

\_\_\_\_\_

- |                                       |                      |                                      |                      |
|---------------------------------------|----------------------|--------------------------------------|----------------------|
| 1. Morris is a pirate.                | <input type="text"/> | 21. Dorothy has new earrings.        | <input type="text"/> |
| 2. Gary flew in the airplane.         | <input type="text"/> | 22. We will exercise first.          | <input type="text"/> |
| 3. He put his arm around her.         | <input type="text"/> | 23. The forest is full of animals.   | <input type="text"/> |
| 4. Barry found an arrowhead.          | <input type="text"/> | 24. My bike is in the garage.        | <input type="text"/> |
| 5. They will arrive tomorrow.         | <input type="text"/> | 25. Did you see the gorilla?         | <input type="text"/> |
| 6. The arrow hit the target.          | <input type="text"/> | 26. Harry went on a hayride.         | <input type="text"/> |
| 7. Terry is an attorney.              | <input type="text"/> | 27. Teresa wears a hearing aid.      | <input type="text"/> |
| 8. What a bargain!                    | <input type="text"/> | 28. A hurricane has strong winds.    | <input type="text"/> |
| 9. Why is that dog barking?           | <input type="text"/> | 29. Pat loves his Irish setter.      | <input type="text"/> |
| 10. Your beard is soft.               | <input type="text"/> | 30. Maryland is a state.             | <input type="text"/> |
| 11. Can you pick berries with me?     | <input type="text"/> | 31. Morris lives in Oregon.          | <input type="text"/> |
| 12. She always takes a camera.        | <input type="text"/> | 32. This is a narrow hallway.        | <input type="text"/> |
| 13. A canary is a bird.               | <input type="text"/> | 33. Dad took me to the parade.       | <input type="text"/> |
| 14. I will send him a card.           | <input type="text"/> | 34. Let's have a picnic in the park. | <input type="text"/> |
| 15. This casserole has carrots in it. | <input type="text"/> | 35. The pearls are in her purse.     | <input type="text"/> |
| 16. Please pass the celery.           | <input type="text"/> | 36. Teresa is sharing the candy.     | <input type="text"/> |
| 17. We went to church yesterday.      | <input type="text"/> | 37. Sherry wore a plaid skirt.       | <input type="text"/> |
| 18. Dan is a circus clown.            | <input type="text"/> | 38. I am sorry.                      | <input type="text"/> |
| 19. It's time to pick the corn.       | <input type="text"/> | 39. What is your favorite story?     | <input type="text"/> |
| 20. Did you write in your diary?      | <input type="text"/> | 40. A turtle has a hard shell.       | <input type="text"/> |

© 1993, Super Dupree School Co.

\_\_\_\_\_  
Name Date

\_\_\_\_\_  
Helper's Signature

Skill: Medial R in sentences



# Final R Words

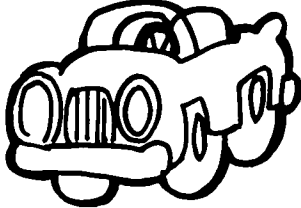
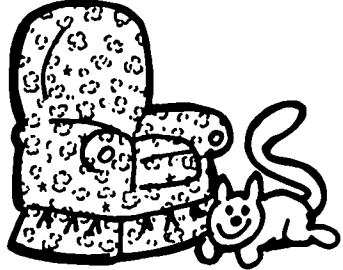

Instructions \_\_\_\_\_

 <p><b>bear</b></p>	 <p><b>car</b></p>	 <p><b>chair</b></p>
--	---	---

\_\_\_\_\_

\_\_\_\_\_

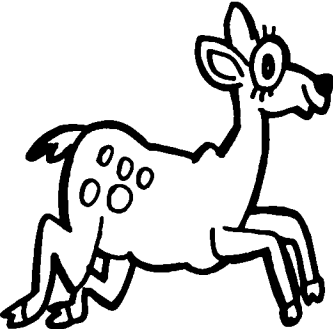
\_\_\_\_\_

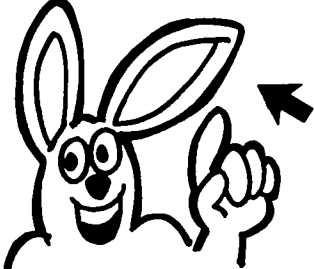
 <p><b>deer</b></p>	 <p><b>door</b></p>	 <p><b>ear</b></p>
---	---	--

\_\_\_\_\_

\_\_\_\_\_

\_\_\_\_\_

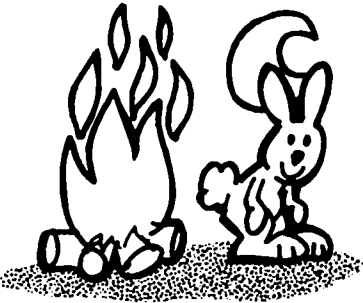
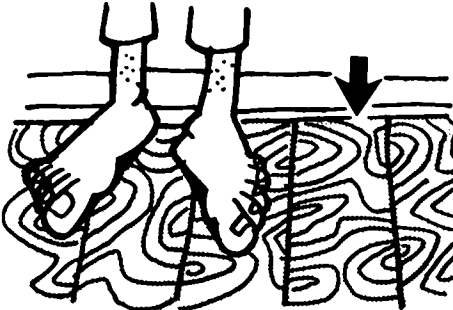
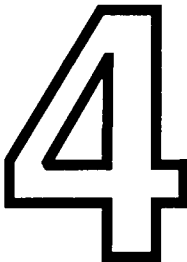
 <p><b>fire</b></p>	 <p><b>floor</b></p>	 <p><b>four</b></p>
--	--	--

\_\_\_\_\_

\_\_\_\_\_

\_\_\_\_\_

© 1993, Super Dupers School Co.

Name \_\_\_\_\_ Date \_\_\_\_\_

Helper's Signature \_\_\_\_\_

Speech-Language Pathologist \_\_\_\_\_

Skill: Final R in words

# Final R Words

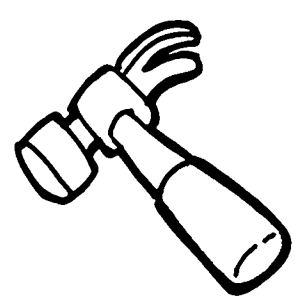
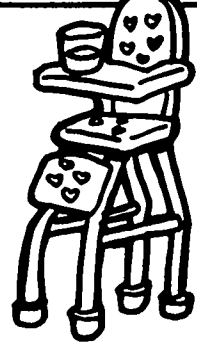

Instructions \_\_\_\_\_

 <p><b>guitar</b></p>	 <p><b>hammer</b></p>	 <p><b>highchair</b></p>
--	--	---

\_\_\_\_\_

\_\_\_\_\_

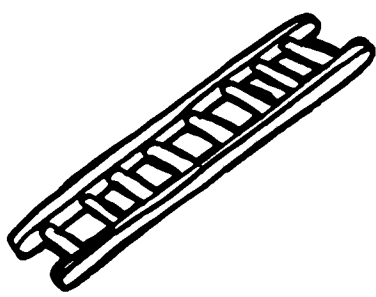

\_\_\_\_\_

 <p><b>juggler</b></p>	 <p><b>ladder</b></p>	 <p><b>letter</b></p>
--	--	---

\_\_\_\_\_

\_\_\_\_\_

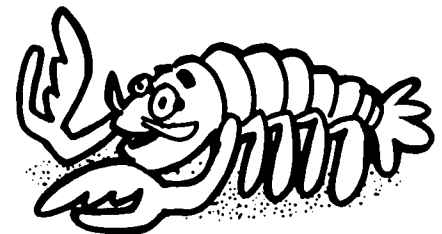
\_\_\_\_\_

 <p><b>lobster</b></p>	 <p><b>matador</b></p>	 <p><b>mother</b></p>
---	--	--

\_\_\_\_\_

\_\_\_\_\_

\_\_\_\_\_

Name \_\_\_\_\_

Date \_\_\_\_\_



Helper's Signature \_\_\_\_\_

Skill: Final R in words

Speech-Language Pathologist \_\_\_\_\_

# Final R Words

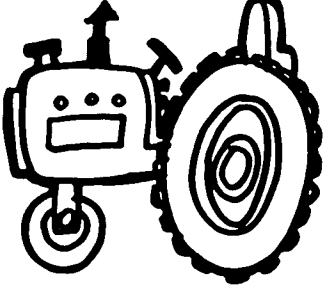

Instructions \_\_\_\_\_

 <p>tiger</p>	 <p>tractor</p>	 <p>umpire</p>
--	--	---

\_\_\_\_\_

\_\_\_\_\_

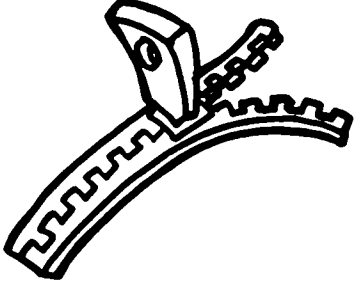

\_\_\_\_\_

 <p>vampire</p>	 <p>wheelchair</p>	 <p>zipper</p>
---	---	--

\_\_\_\_\_

\_\_\_\_\_

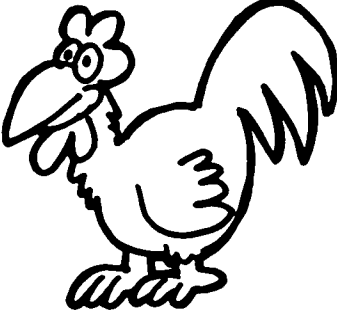
\_\_\_\_\_

 <p>plumber</p>	 <p>rooster</p>	 <p>shoulder</p>
--	--	---

\_\_\_\_\_

\_\_\_\_\_

\_\_\_\_\_

Name \_\_\_\_\_

Date \_\_\_\_\_

Helper's Signature \_\_\_\_\_

Skill: Final R in words

Speech-Language Pathologist

# Final R Sentences



## Instructions

---

---

- |                                    |                      |                                    |                      |
|------------------------------------|----------------------|------------------------------------|----------------------|
| 1. I admire my teacher.            | <input type="text"/> | 21. My father is a juggler.        | <input type="text"/> |
| 2. An alligator has sharp teeth.   | <input type="text"/> | 22. I found a feather.             | <input type="text"/> |
| 3. The bear is in the woods.       | <input type="text"/> | 23. This flower smells sweet.      | <input type="text"/> |
| 4. Will the bottle float ashore?   | <input type="text"/> | 24. She cut her hair today.        | <input type="text"/> |
| 5. Mr. Owen is a baker.            | <input type="text"/> | 25. The hammer is here.            | <input type="text"/> |
| 6. The beaver built a dam.         | <input type="text"/> | 26. When did you see her?          | <input type="text"/> |
| 7. Where is your brother?          | <input type="text"/> | 27. The show lasts one hour.       | <input type="text"/> |
| 8. Let's make a campfire.          | <input type="text"/> | 28. Tim keeps pennies in a jar.    | <input type="text"/> |
| 9. Her car is in the driveway.     | <input type="text"/> | 29. May I borrow your ladder?      | <input type="text"/> |
| 10. I care about you.              | <input type="text"/> | 30. She wrote a letter to Sue.     | <input type="text"/> |
| 11. Please sit in this chair.      | <input type="text"/> | 31. The lobster is in the ocean.   | <input type="text"/> |
| 12. Did she do her chore?          | <input type="text"/> | 32. You are a mature person.       | <input type="text"/> |
| 13. His dog has a collar.          | <input type="text"/> | 33. My mother is fantastic.        | <input type="text"/> |
| 14. Which dinosaur is the biggest? | <input type="text"/> | 34. He will deliver the newspaper. | <input type="text"/> |
| 15. Our baby wears a diaper.       | <input type="text"/> | 35. The kitty began to purr.       | <input type="text"/> |
| 16. She is a famous doctor.        | <input type="text"/> | 36. Her dad uses a razor to shave. | <input type="text"/> |
| 17. We left the door open.         | <input type="text"/> | 37. What's the score?              | <input type="text"/> |
| 18. The fair is coming to town.    | <input type="text"/> | 38. Donna takes a shower at night. | <input type="text"/> |
| 19. Hank lit the fire.             | <input type="text"/> | 39. I will wear a sweater.         | <input type="text"/> |
| 20. The spoon fell to the floor.   | <input type="text"/> | 40. Your jacket has a zipper.      | <input type="text"/> |

© 1993, Super Dupere School Co.

Name \_\_\_\_\_ Date \_\_\_\_\_

Helper's Signature \_\_\_\_\_

Skill: Final R in sentences

Speech-Language Pathologist

# Initial BR Blend Words

Instructions \_\_\_\_\_

\_\_\_\_\_

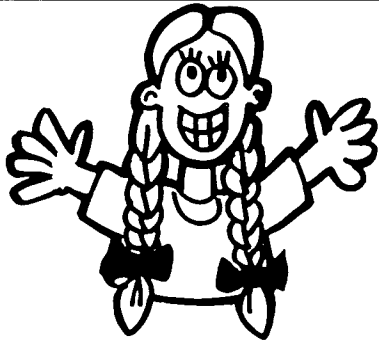

braids

\_\_\_\_\_

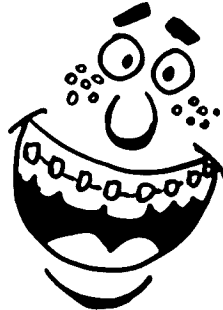

braces

\_\_\_\_\_

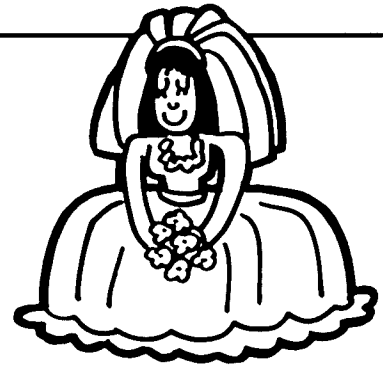

bride

\_\_\_\_\_

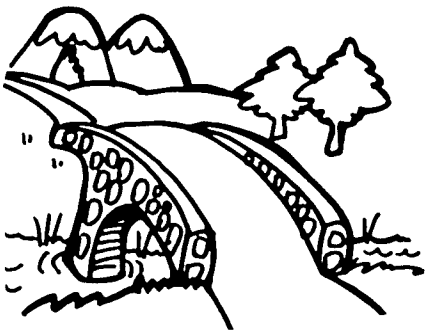

bridge

\_\_\_\_\_

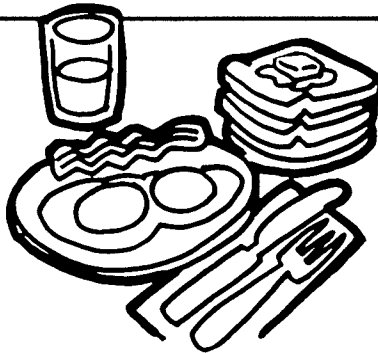

breakfast

\_\_\_\_\_

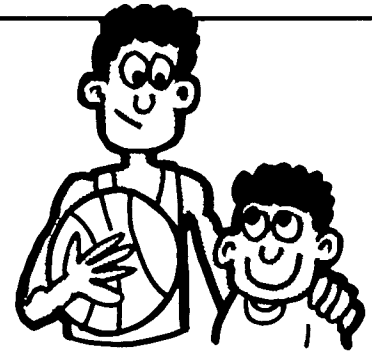

brother

\_\_\_\_\_



broom

\_\_\_\_\_



bread

\_\_\_\_\_

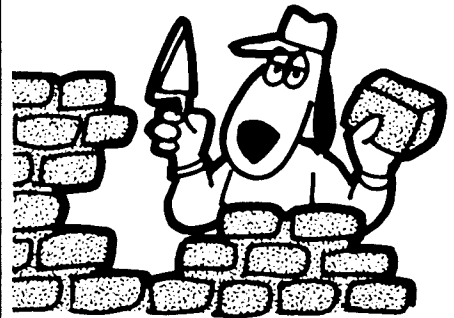

bricks

\_\_\_\_\_

© 1993, Super Dupers, School Co.

Name \_\_\_\_\_

Date \_\_\_\_\_

Helper's Signature \_\_\_\_\_

Speech-Language Pathologist \_\_\_\_\_

Skill: Initial BR blends in words

# Initial DR Blend Words

Instructions \_\_\_\_\_



dream

\_\_\_\_\_

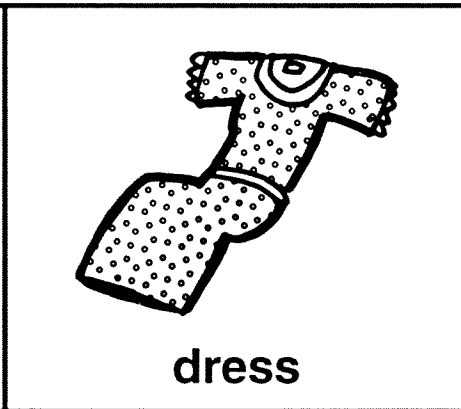

dress

\_\_\_\_\_

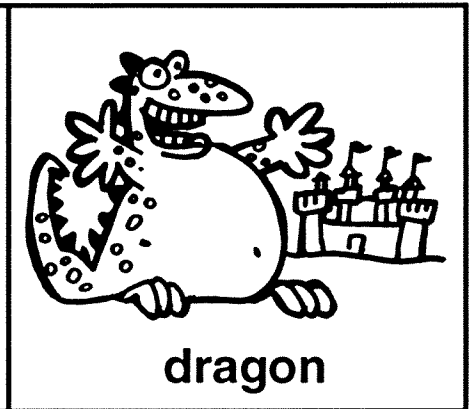

dragon

\_\_\_\_\_

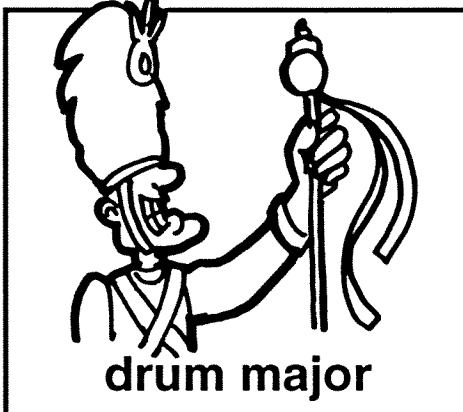

drum major

\_\_\_\_\_

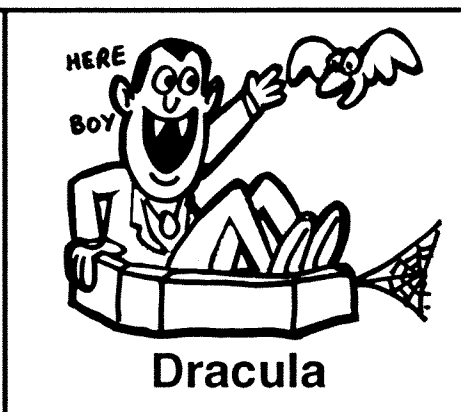

Dracula

\_\_\_\_\_



drink

\_\_\_\_\_

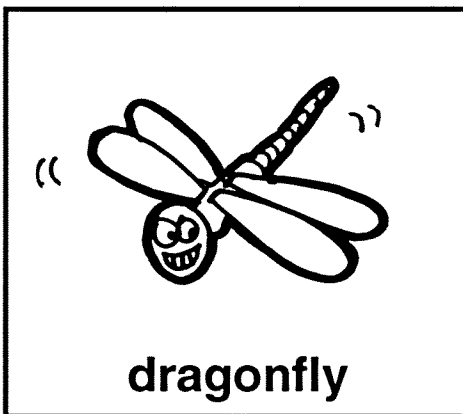

dragonfly

\_\_\_\_\_

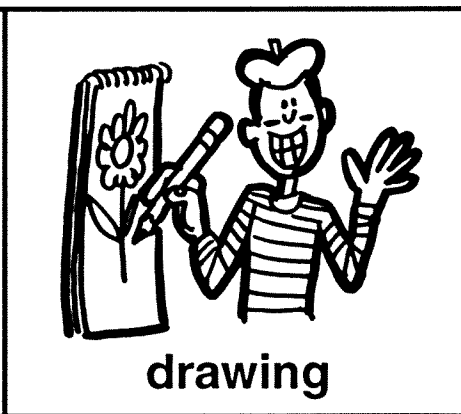

drawing

\_\_\_\_\_



driving

\_\_\_\_\_

© 1993, Super Dupers School Co.

Name \_\_\_\_\_ Date \_\_\_\_\_



Speech-Language Pathologist \_\_\_\_\_

Helper's Signature \_\_\_\_\_

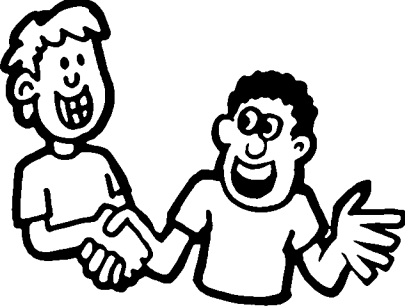
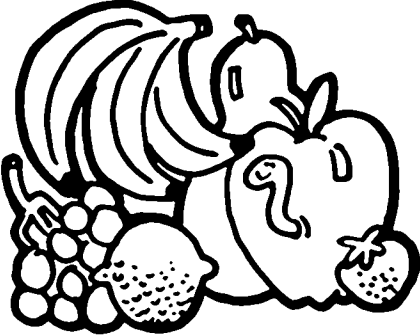

Skill: Initial DR blends in words

# Initial FR Blend Words

Instructions \_\_\_\_\_

 <p><b>friends</b></p>	 <p><b>fruit</b></p>	 <p><b>french fries</b></p>
---	--	--

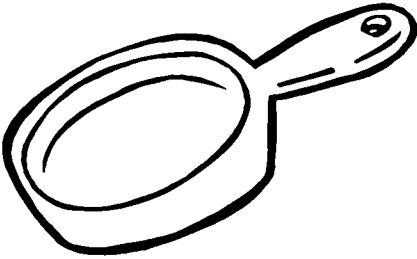

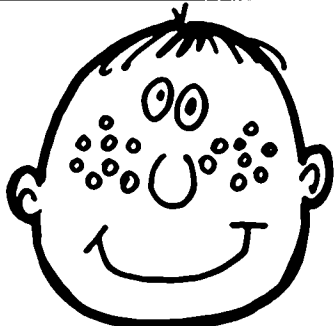
 <p><b>frying pan</b></p>	 <p><b>frog</b></p>	 <p><b>freckles</b></p>
---	--	---

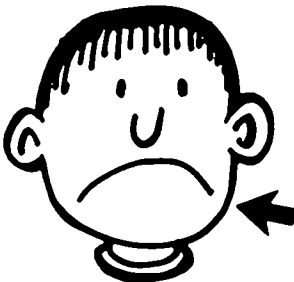
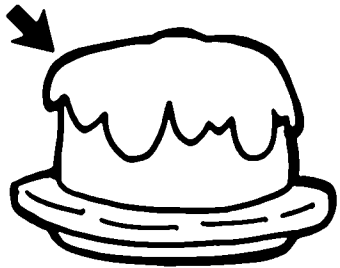

 <p><b>frankfurter</b></p>	 <p><b>frown</b></p>	 <p><b>frosting</b></p>
---	---	--



© 1993, Super Dupers School Co.

Name \_\_\_\_\_ Date \_\_\_\_\_

Speech-Language Pathologist \_\_\_\_\_

Helper's Signature \_\_\_\_\_

Skill: Initial FR blends in words

# Initial GR Blend Words

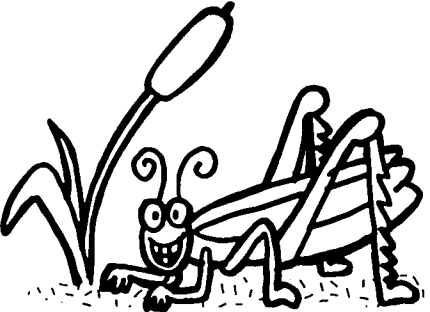
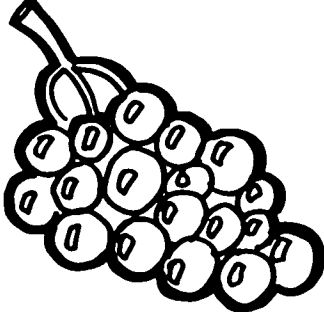
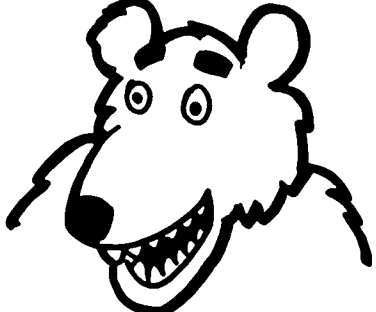

Instructions \_\_\_\_\_

 <p><b>grasshopper</b></p>	 <p><b>grapes</b></p>	 <p><b>grizzly bear</b></p>
---	--	--

--	--	--	--	--	--	--	--	--	--	--	--

--	--	--	--	--	--	--	--	--	--	--	--

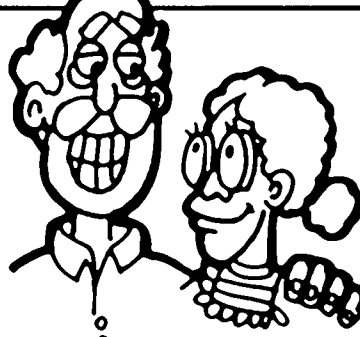

--	--	--	--	--	--	--	--	--	--	--	--

 <p><b>groceries</b></p>	 <p><b>grandparents</b></p>	 <p><b>grass</b></p>
--	---	--

--	--	--	--	--	--	--	--	--	--	--	--

--	--	--	--	--	--	--	--	--	--	--	--

--	--	--	--	--	--	--	--	--	--	--	--

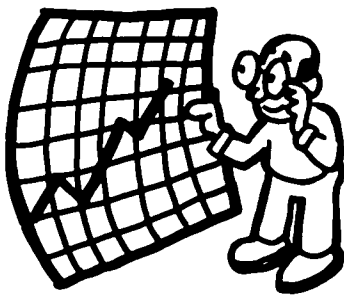
 <p><b>grapefruit</b></p>	 <p><b>group</b></p>	 <p><b>graph</b></p>
--	---	---

--	--	--	--	--	--	--	--	--	--	--	--

--	--	--	--	--	--	--	--	--	--	--	--

--	--	--	--	--	--	--	--	--	--	--	--

© 1993, Super Dupers School Co.

Name \_\_\_\_\_ Date \_\_\_\_\_

Helper's Signature \_\_\_\_\_

Speech-Language Pathologist \_\_\_\_\_

Skill: Initial GR blends in words



# Initial KR Blend Words

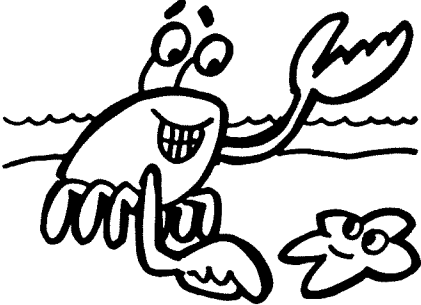
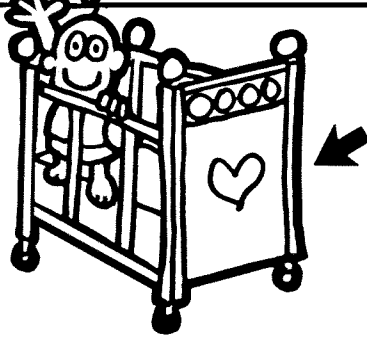
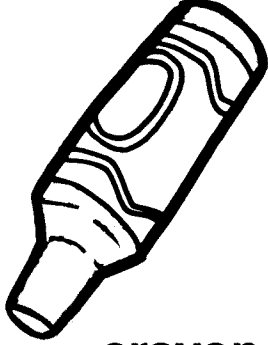

Instructions \_\_\_\_\_

 <p>crab</p>	 <p>crib</p>	 <p>crayon</p>
---	--	---

--	--	--	--	--	--	--	--	--	--

--	--	--	--	--	--	--	--	--	--

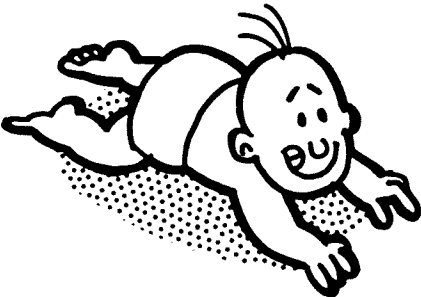
--	--	--	--	--	--	--	--	--	--

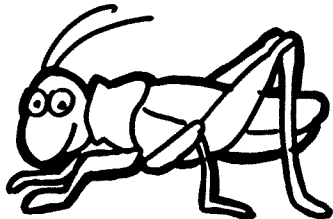
 <p>crawling</p>	 <p>crown</p>	 <p>cricket</p>
--	---	---

--	--	--	--	--	--	--	--	--	--

--	--	--	--	--	--	--	--	--	--

--	--	--	--	--	--	--	--	--	--

 <p>crocodile</p>	 <p>crying</p>	 <p>crowded</p>
--	--	--

--	--	--	--	--	--	--	--	--	--

--	--	--	--	--	--	--	--	--	--

--	--	--	--	--	--	--	--	--	--

Name \_\_\_\_\_ Date \_\_\_\_\_

Helper's Signature \_\_\_\_\_

Speech-Language Pathologist \_\_\_\_\_

Skill: Initial KR blends in words

# Initial PR Blend Words

Instructions \_\_\_\_\_

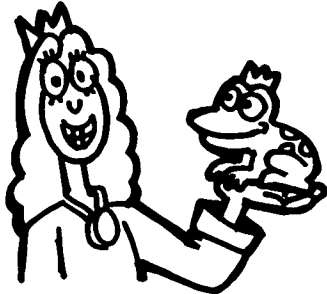

**princess**

□ □ □ □ □ □ □ □ □ □

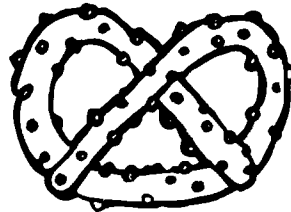

**pretzel**

□ □ □ □ □ □ □ □ □ □

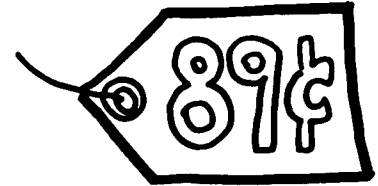

**price**

□ □ □ □ □ □ □ □ □ □



**prairie dog**

□ □ □ □ □ □ □ □ □ □



**prince**

□ □ □ □ □ □ □ □ □ □



**prize**

□ □ □ □ □ □ □ □ □ □



**present**

□ □ □ □ □ □ □ □ □ □



**prunes**

□ □ □ □ □ □ □ □ □ □



**practice**

□ □ □ □ □ □ □ □ □ □

© 1993, Super Dupere School Co.

Name \_\_\_\_\_ Date \_\_\_\_\_



Speech-Language Pathologist \_\_\_\_\_

Helper's Signature \_\_\_\_\_

Skill: Initial PR blends in words

# Initial TR Blend Words

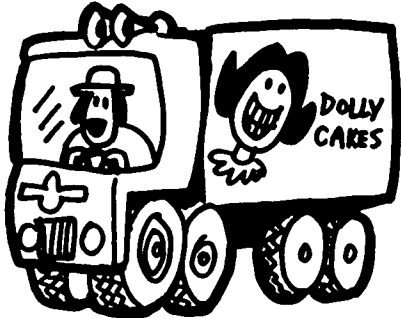
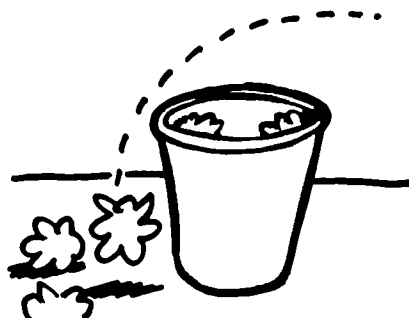

Instructions \_\_\_\_\_

 <p><b>truck</b></p>	 <p><b>trash</b></p>	 <p><b>tree</b></p>
---	--	--

--	--	--	--	--	--	--	--	--	--	--	--

--	--	--	--	--	--	--	--	--	--	--	--

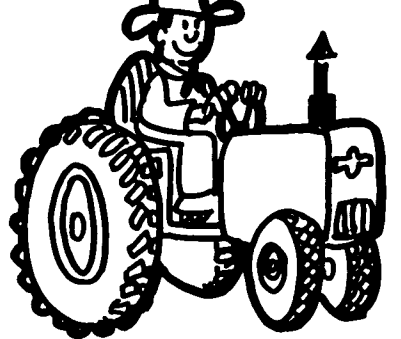
--	--	--	--	--	--	--	--	--	--	--	--

 <p><b>tractor</b></p>	 <p><b>triplets</b></p>	 <p><b>treasure</b></p>
--	--	---

--	--	--	--	--	--	--	--	--	--	--	--

--	--	--	--	--	--	--	--	--	--	--	--

--	--	--	--	--	--	--	--	--	--	--	--

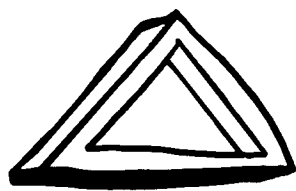
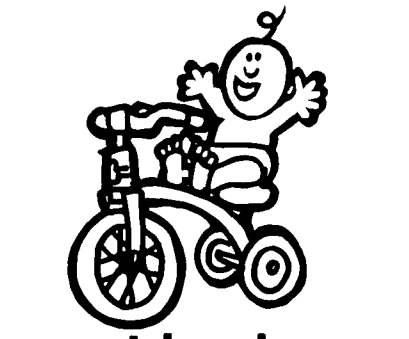
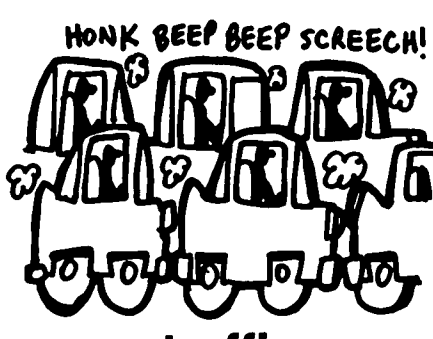
 <p><b>triangle</b></p>	 <p><b>tricycle</b></p>	 <p><b>traffic</b></p>
--	---	---

--	--	--	--	--	--	--	--	--	--	--	--

--	--	--	--	--	--	--	--	--	--	--	--

--	--	--	--	--	--	--	--	--	--	--	--

© 1993, Super Dupere School Co.

Name \_\_\_\_\_

Date \_\_\_\_\_

Helper's Signature \_\_\_\_\_

Speech-Language Pathologist \_\_\_\_\_

Skill: Initial TR blends in words